

Data Sheet



Article number: 03445180

Description: Fluro Heavy Duty Spherical Plain Bearing GE 180 EW-2RS
Hole \varnothing 180

Note: 180

Measures

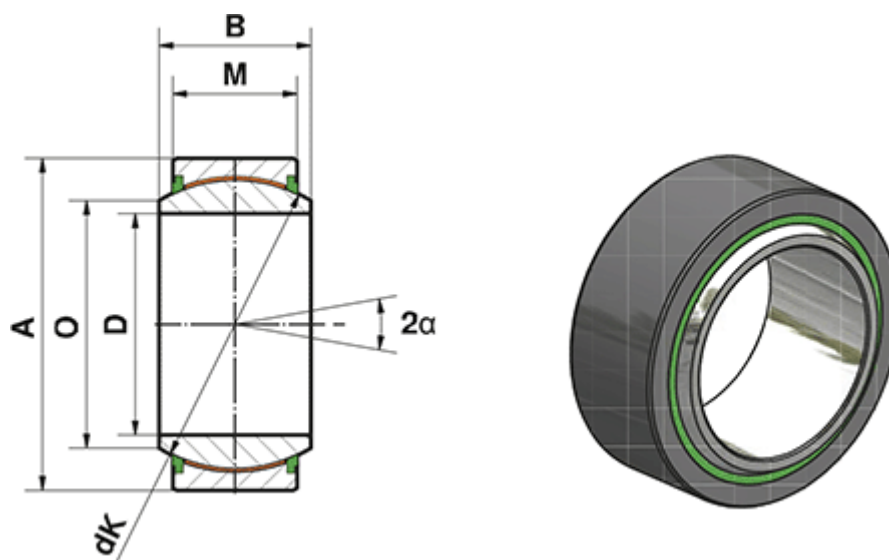

A	= 260	Static load C0 (kN) = 7200
a (degrees)	= 6	Weight (g) = 17400
B	= 105	
D	= 180	
dk	= 225	
Dynamic load C (kN)	= 4320	
M	= 80	
O	= 198.9	